

Installing the Enphase Q Aggregator

To install the Enphase Q Aggregator, read and follow all warnings and instructions in this Guide and in the Enphase IQ System Installation and Operation Manual at enphase.com/support. If you do not fully understand any of the concepts, terminology, or hazards outlined in these instructions, refer installation to a qualified electrician or installer. These instructions are not meant to be a complete explanation of a renewable energy system. All installations must comply with national and local electrical codes. Professional installation is recommended.

IMPORTANT: Enphase IQ Envoy and IQ 6 and IQ 6+ Micros do not communicate with, and should not be used with, previous generation Enphase Microinverters and Envoys. Always use the Q Aggregator and other Q accessories with IQ 6 and/or IQ 6+ Microinverters.

How It Works

Use the Enphase Q Aggregator to bring together up to three branches of microinverters, center feed branch connections, or connect a remote part of the array using Enphase Q Field Wireable Connectors.

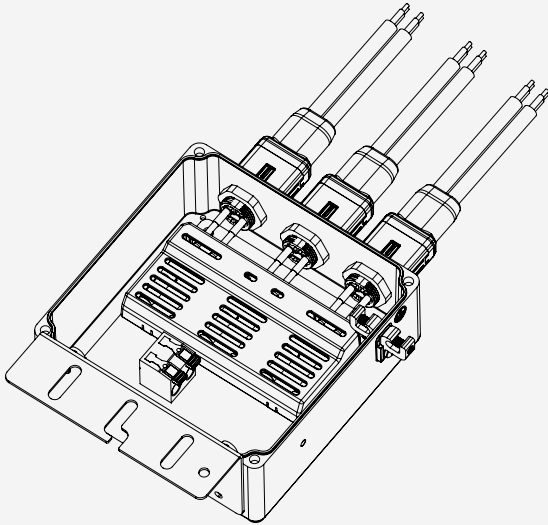

Features

- Lets you install systems up to 11.5 kW with only two line conductors and a ground coming from the roof
- Usable in any position up to 45 degrees from horizontal (NEMA 3R, includes drain holes)
- The aggregator bracket is ready to install on rail, can be flipped for roof or block mount installs, and allows you to fit conduit into either or both sides

PREPARATION

- Check the box for the following items:
 - Enphase Q Aggregator
 - One bulkhead connector cap (Q-BA-CAP). You may need to order an extra cap if you connect only one branch circuit to the aggregator.
 - *Quick Install Guide* (this document)
 - Check that you have these **required** items:
 - Enphase Q Aggregator(s) for multiple branch arrays
 - Drill with an appropriately sized hole saw
 - Screwdrivers
 - Wire stripping tool
 - Torque wrench and sockets for mounting hardware
 - 75° to 90° C-rated conductors for connections between the Q Aggregator and main PV breaker
 - Enphase disconnect tool
 - Protect your system with lightning and/or surge suppression devices at the sub or main panel.
 - Protect the Q Aggregator with a maximum 60-amp over-current protection device (OCPD).
 - Size the AC wire gauge to account for voltage rise. Select the correct wire size based on OCPD size and on the distance from the beginning of the Enphase Q Cable to the breaker in the load center. Design for a voltage rise total of less than 2% for the sections from the Enphase Q Cable to the breaker in the load center. Refer to the Voltage Rise Technical Brief at enphase.com/support for more information.
- Best practice:** Use a Q Aggregator and Enphase Q Field Wireable Connectors to center-feed each branch circuit to minimize voltage rise in a fully-populated branch.
- Plan to install the Q Aggregator in a location that will be under the modules when the array is complete.

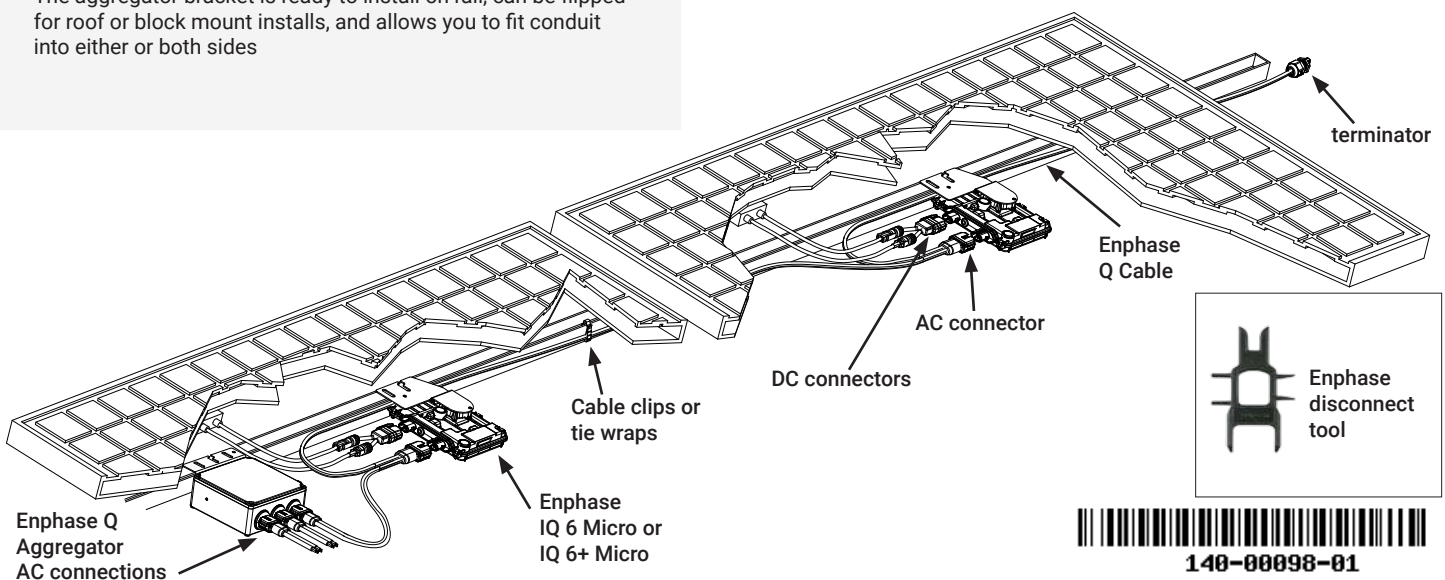

INSTALLATION

1 Plan the Connections

- A) Plan for the following connections:
- One maximum 60 A home run: Pass the home run cable through wet/dry-rated conduit gland, and secure in the cage clamp lugs to the terminal connectors. Use standard home run conduit size (1/2, 3/4, or 1-inch).
 - Up to three 20 A branch circuits: Three bulkhead mounted connectors allow for the direct connection of the Q Cable.
 - PV Array ground: The ground lug connection that passes through the enclosure allows you to connect racking and module ground to the main panel ground.

2 Plan the Location

- A) Select a location that will be under the modules when the array is complete, but that will also be accessible for making connections later.
- B) Ensure that you can bring conduit into the Q Aggregator from the upper left or right side where indicated by pilot hole indents.

BEST PRACTICE: Lay out your cable runs before determining the Q Aggregator location.

3 Drill a Hole for Conduit

- A) Prep conduit with an offset to approximate area and position the Q Aggregator to double check your drill location.
- B) Remove the Q Aggregator cover and drill a hole for up conduit: Typical openings are 2.2 cm, 2.8 cm, or 3.5 cm (0.885", 1.115", or 1.362"), but check the conduit fittings you are using to verify size.

 **WARNING:** Take care not to damage the circuit board.

- C) Dump or blow out any debris from this drilling operation.

4 Attach the Q Aggregator to the PV Rail

WARNINGS:

- Install the Q Aggregator under the PV module to avoid direct exposure to rain, UV, and other harmful weather events.
- Mount the Q Aggregator off of the roof surface for rain and snow resistance.
- Always install the Q Aggregator with the label side up. Do not mount it upside down. You can flip the bracket for roof or block mounting.
- When transitioning between rows, secure the cable to the nearest rail to prevent cable damage.

- A) Install Q Aggregator on rail. Allow a minimum of 1.9 cm (0.75") between the roof and the Q Aggregator. Also allow 1.3 cm (0.50") between the back of the PV module and the top of the Q Aggregator.
- B) Install the Q Aggregator on the rail and mount loosely.
- C) Use a conduit fitting rated for outdoor use to secure the conduit to the Q Aggregator.
- D) Provide an AC connection (home run) from the Enphase Q Aggregator back to the electricity network connection using equipment and practices as required by local jurisdictions.
- E) Tighten rail connections to 80 in-lbs (9 N m), and make sure that conduit fittings are secured and water tight.
- F) Secure and check all connections.

5 Wire the Q Aggregator

- A) Pull the line conductors and ground up to the Q Aggregator.
- B) Strip the two line conductors (18 mm/0.7" strip length) using the guide on the upper surface of the cage clamp style main lugs.
- C) Secure the conductors (12 AWG to 4 AWG max) in these lugs and make sure that the orange handles are in the fully down position.
- D) Strip and bring the ground wire inside the Q Aggregator to the ground lug. This ground lug passes through to outside for use in grounding the rack and modules as needed.
- E) Secure racking ground to the ground lug.
- F) Torque the ground connections as follows:
- 14-10 AWG / 20 in-lbs (2.25 N m)
 - 8 AWG / 25 in-lbs (2.82 N m)
 - 6-4 AWG / 35 in-lbs (3.95 N m)
- G) Check your connections for soundness.

You have completed the wiring for up to three plug and play branch circuits in your system.

6 Replace the Cover

- A) Make sure that the drain holes on the bottom of the Q Aggregator are free from debris.
- B) Check the seal on all sides for trapped debris. Remove any debris, if needed.
- C) Replace the cover on the Q Aggregator and torque screws to 10 in-lbs (1.1 N m).
- D) Check that the Q Aggregator is properly sealed.
- E) Cap any unused branch circuit connections.

The Q Aggregator is now ready for branch circuit connections.

 **DANGER!** Never connect a single branch circuit to multiple branch circuit connections on the Q Aggregator.

To remove a sealing cap or AC connector, you must use an Enphase disconnect tool.

Each Q Aggregator includes one bulkhead connector cap. You can purchase additional caps from your distributor.

TROUBLESHOOTING

 **DANGER!** Risk of electric shock. Some tasks are done with live circuits in an outdoor rooftop environment. Always wear proper personal protective equipment (PPE) for electrical and rooftop tasks.

One or More Branches Not Generating

Without removing the cover:

- A) Verify that voltage is within range at the PV breaker at the main panel when measuring from L1 to L2.
- B) Power off the PV circuit and use a voltmeter to verify that the circuit is turned off. Use Lockout/Tagout procedures.
- C) On the roof, disconnect the Q Cable connectors from all (up to three) of the branch circuit bulkhead connectors on the Q Aggregator and seal connectors.
- D) Turn the PV circuit on at the main panel and again verify that 240V is present from L1 to L2.
- E) Using PPE, and taking care not to short the L1, L2 pins within each connector, use a voltage meter to determine if each connector on the Q Aggregator has 240V present from L1 to L2.
- F) If all connectors show proper voltage then the Q Aggregator is working correctly.
- G) If some connectors exhibit proper voltage, but, after repeated testing, other connectors do not exhibit proper voltage, continue to the Q Aggregator board removal and replacement procedures.
- H) If all connectors do not show voltage and the main PV circuit from the main panel is active per step D, continue with the following troubleshooting procedure.

Troubleshoot When All Circuits Appear Non-Functioning

- A) Verify that the PV breaker at the main panel reads 240V when measuring from L1 to L2.
- B) Power off the PV Circuit and verify with voltmeter that the circuit is turned off. Use Lockout/Tagout procedures.
- C) On the roof, open the Q Aggregator using a standard screwdriver blade on the four captured screws on the cover.
- D) Use a voltmeter or electrical tester to verify that circuit coming to the main lug of the Q Aggregator is not live.
- E) Inspect the Q Aggregator for evidence of loose connections at the main lug or look for evidence of multiple blown fuses.
- F) Remove tools and/or screws from the Q Aggregator, reactivate the PV circuit, and test for voltage on the conductors coming from main panel.
- G) If no voltage is coming from the main panel check your electrical wiring from the main panel.
- H) If there is voltage at Q Aggregator main lug, and if the wires appear to be stripped appropriately and terminated with orange handles down, continue to the Q Aggregator board removal and replacement procedures.

REPLACING PARTS

 **DANGER!** Risk of electric shock. Some tasks are done with live circuits in an outdoor rooftop environment. Always wear proper personal protective equipment (PPE) for electrical and rooftop tasks.

The following details replacement of part number Q-BA-3-1P-PCBA.

Remove Q Aggregator Fuse and Connection Board

- A) Power off the PV circuit and use a voltmeter to verify that the circuit is turned off. Use Lockout/Tagout procedures.
- B) On the roof, open the Q Aggregator using a standard screwdriver blade on the four screws on the cover.
- C) Assuming that the Q Aggregator may still be electrified, remove the fuse protective cover by freeing the tabs closest to the main lug. Set aside the fuse cover for future use.
- D) Check for voltage across all fuse terminals. **If, and only if there is no voltage at any of the terminals in the Q Aggregator**, remove and tie back the main electrical connections.
- E) With the main connections disconnected, use a standard multi-meter, (not a Megger) to check the PV circuits for obvious signs of short circuits.
- F) Physically inspect the cabling and terminations for signs of pinching, insulation damage, or bad terminations.
- G) If none are found, use a screwdriver to hold back the locking tab while depressing the spring clip, and then use a gentle rocking motion to remove the flag terminal. No electrical connections to the circuit board should now exist.
- H) Use a Phillips head screwdriver to remove the five screws that secure the board.
 **DANGER!** Risk of injury. Do not chase dropped screws. They can be replaced with standard stainless metric hardware.
- I) Set aside the screws for future use.

Replace Q Aggregator Fuse and Connection Board

- A) On the roof, open the Q Aggregator using a standard screwdriver blade on the four captured screws on the cover.
- B) Use a voltmeter or electrical tester to again verify that the main circuit coming into the box is not energized.
- C) Assuming that the Q Aggregator may still be electrified, remove the fuse protective cover by freeing the tabs closest to the main lug. Set aside the fuse cover for future use.
- D) Check for voltage across all fuse terminals. **If, and only if there is no voltage at any of the terminals in the Q Aggregator**, remove and tie back the main electrical connections.
- E) Remove the replacement board from packaging and insert it into the Q Aggregator, taking care to line up with tabs and screw holes.
- F) Recover the five screws removed from the original board and use these to secure the new board. Torque screws to 9.7 in-lbs (1.1 N m).
- G) Reattach the six locking flag terminals to the nearest terminals on the Q Aggregator, taking care not to invert polarity. Connections should be straight across from the bulkhead connectors.
- H) Reattach the main lug connections and check that the connections are secure. Reconnect the PV array connections.
- I) With no tools or loose screws in the Q Aggregator, reactivate the PV circuit and test for voltage at the inputs and outputs of the fuses.
- J) If voltages are appropriate in all locations, turn the power off and replace the fuse cover.
- K) Make one last check of connections and re-secure the lid on the Q Aggregator. Check the seal on all sides for trapped debris. Remove any debris, if needed.

SAFETY

IMPORTANT SAFETY INSTRUCTIONS.

SAVE THIS INFORMATION. This guide contains important instructions to follow during installation of the Enphase Q Aggregator.



WARNING: Hot internal surfaces.



DANGER: Refer to safety instructions.



DANGER: Risk of electric shock.

Safety Symbols	
	DANGER: This indicates a hazardous situation, which if not avoided, will result in death or serious injury.
	WARNING: This indicates a situation where failure to follow instructions may be a safety hazard or cause equipment malfunction. Use extreme caution and follow instructions carefully.
	WARNING: Risk of burn. Failure to follow instructions may result in burn injury.
	NOTE: This indicates information particularly important for optimal system operation.

Safety Instructions	
	DANGER: Risk of electric shock. Do not use Enphase equipment in a manner not specified by the manufacturer. Doing so may cause death or injury to persons, or damage to equipment.
	DANGER: Risk of electric shock. Risk of fire. Be aware that installation of this equipment includes risk of electric shock. Do not open without first removing AC power from the Enphase System. Disconnect the power coming from the photovoltaics before servicing or installing.
	DANGER: Risk of electric shock. Risk of fire. Before making any connections verify that the circuit breakers are in the off position. Double check all wiring before applying power.
	DANGER: Risk of electric shock. Risk of fire. Only use electrical system components approved for wet locations, including but not limited to conduit fittings.
	DANGER: Risk of electric shock. Risk of fire. Use the circuit in the Enphase Q Aggregator only for connecting Enphase Q Cable and Microinverters. No other loads or sources are allowed.
	DANGER: Risk of electric shock. Risk of fire. Only qualified personnel should install, troubleshoot, or replace the Enphase Q Aggregator.
	DANGER: Risk of electric shock. Improper servicing of the Q Aggregator or its components may result in a shock, fire or explosion. To reduce these risks, disconnect all wiring before attempting any maintenance.
	DANGER: Risk of electric shock. Risk of fire. Ensure that all AC and DC wiring is correct and that none of the AC wires are pinched, shorted, or damaged.
	DANGER: Risk of electric shock. Risk of fire. Protect the Q Aggregator with a 60 A maximum over current protection device (OCPD).
	DANGER: Risk of electric shock. Risk of fire. Do not attempt to repair the Enphase Q Aggregator, other than to replace parts only as directed in this guide. Tampering with the board or damaging the conformal coating will void the warranty.
	DANGER: Risk of electric shock. Risk of fire. Make sure the conductors are not damaged. If the exposed wires are damaged, the system may not function properly.
	DANGER: Risk of electric shock. Risk of fire. Do not leave AC connectors on the Enphase Q Cable uncovered for an extended period. You must cover any unused connector with a sealing cap.
	DANGER! Risk of electric shock. Some tasks are done with live circuits in an outdoor rooftop environment. Always wear proper personal protective equipment (PPE) for electrical and rooftop tasks.

	WARNING: Do not expose any connectors to rain or condensation before the connectors are mated.
	WARNING: Install the Q Aggregator under the PV module to avoid direct exposure to rain, UV, and other harmful weather events; mount the Q Aggregator off of the roof surface for rain and snow resistance; and always install the Q Aggregator with the label side up. Do not mount it upside down.
	WARNING: Risk of equipment damage. This product is intended for operation in an environment having a maximum ambient temperature of 55°C (131°F).
	WARNING: When installing the Enphase Q Cable, secure any loose cable to minimize tripping hazard
	WARNING: Before installing or using the Enphase Q Aggregator, read all instructions and cautionary markings in the technical description, on the Enphase System, and on the photovoltaic (PV) equipment.
	WARNING: Risk of skin burn. The Enphase Q Aggregator may have very hot interior surfaces. To reduce risk of burns, use caution when working with the Q Aggregator.
	NOTE: For problems other than a blown fuse or physical damage, contact Enphase customer service to obtain an RMA (return merchandise authorization) number and start the replacement process.
	NOTE: Install the Q Aggregator in the field with 75°C or 90°C copper conductors sized per local code requirements and voltage drop/rise considerations.
	NOTE: Using unapproved attachments or accessories may result in damage or injury.
	NOTE: Use Class 1 wiring methods for field wiring connections to terminals of a Class 2 circuit. Use only 14 to 4 gauge wire. Select the wire gauge used based on the protection provided by the circuit breakers/fuses. Overcurrent protection must be installed as part of the system installation.
	NOTE: When looping the Enphase Q Cable, do not form loops smaller than 4.75 inches (12 cm) in diameter.
	NOTE: Perform all electrical installations in accordance with all applicable local electrical codes: the Canadian Electrical Code, part 1; the National Electrical Code (NEC); ANSI requirements; and NFPA 70.
	NOTE: To ensure optimal reliability and to meet warranty requirements, install the Enphase Microinverters and Enphase Q Cable according to the instructions in this guide.
	NOTE: Protection against lightning and resulting voltage surge must be in accordance with local standards.

SÉCURITÉ

INSTRUCTIONS IMPORTANTES RELATIVES À LA SÉCURITÉ. VEUILLEZ CONSERVER CES INFORMATIONS.

Ce guide contient des instructions importantes que vous devez suivre lors de l'installation de l'Enphase Q Aggregator.



AVERTISSEMENT : surfaces internes chaudes.



DANGER : Rerportez-vous aux instructions relatives à la sécurité.



DANGER : risque d'électrocution.

Symboles de sécurité et d'alerte	
	DANGER : ce symbole indique une situation dangereuse qui, si elle n'est pas évitée, peut entraîner la mort ou des blessures graves.
	AVERTISSEMENT : ce symbole indique une situation où le non-respect des consignes peut endommager l'appareil ou constituer un risque pour la sécurité. Soyez extrêmement prudent et suivez attentivement les instructions.
	AVERTISSEMENT : risque de brûlure. Le non-respect des instructions peut engendrer des brûlures.
	REMARQUE : ce symbole indique une information particulièrement importante pour le fonctionnement optimal du système.

Instructions relatives à la sécurité	
	DANGER : risque d'électrocution. N'utilisez jamais le matériel Enphase d'une manière non spécifiée par le fabricant. Cela peut entraîner la mort ou des blessures graves, ou endommager l'équipement.
	DANGER : risque d'électrocution. Notez que l'installation de cet équipement présente un risque d'électrocution. N'ouvrez pas sans avoir auparavant débranché la tension AC du système Enphase. Débranchez l'alimentation provenant des modules photovoltaïques avant de procéder à un dépannage ou à une installation.
	DANGER : risque d'électrocution. Risque d'incendie. Avant d'effectuer tout raccordement, assurez-vous que le disjoncteur soit en position d'arrêt (OFF). Vérifiez que le câblage avant de mettre sous tension.
	DANGER : risque d'électrocution. Risque d'incendie. Utilisez uniquement des composants de système électrique approuvés pour les emplacements humides, y compris, mais sans s'y limiter, aux conduits.
	DANGER : risque d'électrocution. Risque d'incendie. Utilisez le circuit dans le Enphase Q Aggregator seulement pour raccorder au câble Enphase Q Cable aux micro-onduleurs Enphase. Aucune autre charge ou source d'électricité n'est permise.
	DANGER : risque d'électrocution. Risque d'incendie. Seul le personnel qualifié est autorisé à installer, dépanner ou remplacer le Enphase Q Aggregator.
	DANGER : risque d'électrocution. L'entretien inadéquat du Enphase Q Aggregator peut causer un incendie, une explosion ou une électrocution. Pour réduire les risques, déconnectez tout le câblage avant de procéder à l'entretien.
	DANGER : risque d'électrocution. Risque d'incendie. Assurez-vous que tout le câblage AC et DC est correct et qu'aucun des câbles AC n'est pincé ou endommagé.
	DANGER : risque d'électrocution. Risque d'incendie. Protégez le Enphase Q Aggregator avec le disjoncteur principal de 60 A max.
	DANGER : risque d'électrocution. Risque d'incendie. Ne tentez pas de réparer vous-même le Enphase Q Aggregator, autre que le remplacement du fusible ou la connexion au tableau électrique, tel qu'indiqué dans ce manuel. L'altération du tableau ou l'endommagement du revêtement pourrait annuler la garantie.
	DANGER : risque d'électrocution. Risque d'incendie. Assurez-vous que les conducteurs ne sont pas endommagés. Si les câbles exposés sont abîmés, il se peut que le système ne fonctionne pas correctement.
	DANGER : risque d'électrocution. Risque d'incendie. Ne laissez pas les connecteurs AC du câble Enphase Q découverts pendant longtemps. Équipez tous les connecteurs inutilisés d'un bouchon d'étanchéité.
	DANGER ! Risque d'électrocution. Ces tâches doivent être effectuées avec des circuits sous tension à l'extérieur. Portez toujours un équipement de protection personnelle approprié pour les travaux électriques et le travail sur les toitures.

	AVERTISSEMENT : N'exposez aucun des connecteurs à la pluie ou à la condensation avant qu'ils soient raccordés.
	AVERTISSEMENT : risque d'endommagement de l'équipement. Ce produit est destiné à être utilisé dans un environnement avec une température ambiante ne dépassant pas les 55 °C (131 °F).
	AVERTISSEMENT : lors de l'installation du câble Enphase Q, fixez un éventuel câble flottant pour éviter tout risque de déclenchement intempestif.
	AVERTISSEMENT : Installez le Enphase Q Aggregator sous le module PV afin d'éviter une exposition directe à la pluie, aux rayons UV ou toute autre intempérie ; montez le Enphase Q Aggregator de façon à ce qu'il ne touche pas à la surface du toit, pour offrir une meilleure résistance à la pluie et à la neige ; toujours installer le Enphase Q Aggregator avec le couvercle sur le dessus. Ne le montez pas à l'envers ou avec le support de fixation retourné lorsque vous l'installez sur un toit.
	AVERTISSEMENT : avant d'installer ou d'utiliser le Enphase Q Aggregator, lisez toutes les instructions et mises en garde figurant dans la description technique, sur le système Enphase et l'équipement photovoltaïque (PV).
	AVERTISSEMENT : risque de brûlure cutanée. Il se peut qu'à l'intérieur du Enphase Q Aggregator les surfaces soient chaudes. Pour réduire le risque de brûlures, soyez prudent lorsque vous manipulez le Enphase Q Aggregator.
	REMARQUE : Pour tout problème, à l'exception d'un fusible grillé, contactez le service client d'Enphase pour obtenir un numéro d'autorisation de retour (numéro RMA) et lancer la procédure de remplacement.
	REMARQUE : Installez le ENPHASE Q Aggregator sur le terrain avec des conducteurs en cuivre classés 75 °C ou 90 °C, selon la réglementation locale et en tenant compte la chute et de la hausse de tension.
	REMARQUE : l'utilisation de systèmes de fixation ou d'accessoires non autorisés peut entraîner des dégâts ou des blessures.
	REMARQUE : utilisez des méthodes de câblage de classe 1 pour les raccordements extérieurs à des terminaux d'un circuit de classe 2. N'utilisez que des fils isolés de calibre 14 à 4. Choisissez l'isolation des conducteurs en fonction du calibre des disjoncteurs ou des fusibles. Vous devez utiliser une protection contre les surintensités pour l'installation du système.
	REMARQUE : lorsque vous enroulez le câble Enphase Q, ne formez aucune boucle inférieure à 12 centimètres de diamètre.
	REMARQUE : Réalisez toutes les installations électriques conformément aux codes de l'électricité locaux en vigueur et à la réglementation en vigueur du code canadien de l'électricité, partie 1 ; la réglementation du National Electrical Code (NEC), du ANSI et du NFPA 70.
	REMARQUE : pour assurer une fiabilité optimale et satisfaire aux exigences de la garantie, installez le micro-onduleur Enphase et le câble Q Enphase selon les instructions fournies dans le présent manuel.
	REMARQUE : la protection contre la foudre et la surtension qui en résulte doit être conforme aux normes locales.