

Item Number	Component	Qty in Kit
1	BRACE, TUBE CBR SQ	1
2	SLEEVE, PIPE BRACE	2
3	NUT, JAM 1/2-13 STEEL HDG	4
4	SCREW, SET 1/2-13 X 1.50 CUP PNT	4
5	BOLT, 1/2-13 HEX GALV	2
6	WASHER, FLAT 1/2 GALV	4
7	WASHER, LOCK SPRING 1/2 GALV	2
8	NUT, HEX 1/2-13 GALV	2

Part Number	Description	Brace Tube Length	Brace Tube Width
70-0200-CBR	SGA 2" (7.5') Brace Assembly (bulk)	88.5"	2.0"
70-0300-CBR	SGA 3" (7.5') Brace Assembly (bulk)	87.0"	2.5"
70-0205-CBR	SGA 2" (9') Brace Assembly, 5-Panel (bulk)	106.5"	2.0"
70-0305-CBR	SGA 3" (9') Brace Assembly, 5-Panel (bulk)	105.0"	2.5"

1) Brace, Tube CBR SQ

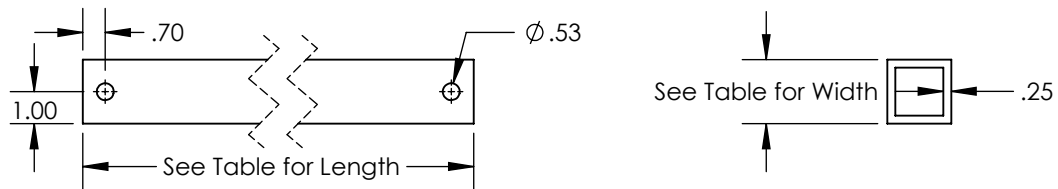

Property	Value
Material	Aluminum
Finish	Mill

2) Sleeve, Pipe Brace

SGA 2"

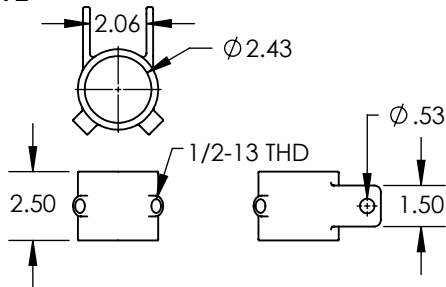

Property	Value
Material	Steel
Finish	Hot-Dip Galvanized

SGA 3"

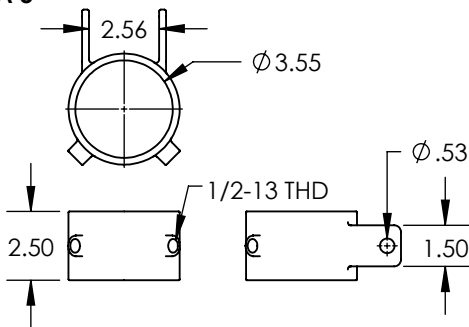

Property	Value
Material	Steel
Finish	Hot-Dip Galvanized

3) Nut, Jam 1/2-13 Steel HDG

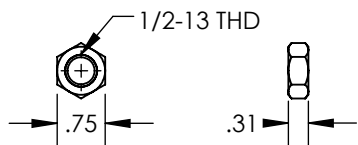

Property	Value
Material	Steel
Finish	Hot-Dip Galvanized

4) Screw, Set 1/2-13 x 1.50 Cup PNT

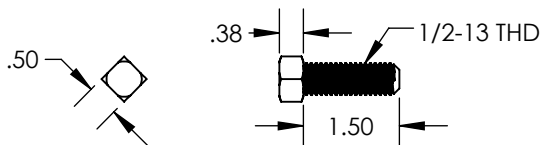

Property	Value
Material	Steel
Finish	Hot-Dip Galvanized

5) Bolt, 1/2-13 Hex Galv

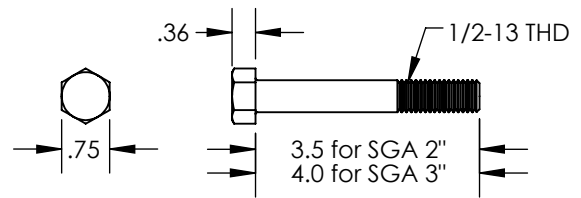

Property	Value
Material	Steel
Finish	Hot-Dip Galvanized

6) Washer, Flat 1/2 Galv

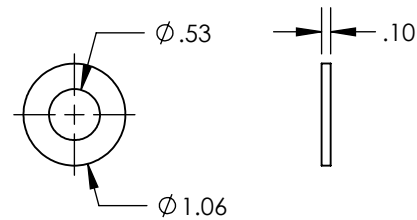

Property	Value
Material	Steel
Finish	Hot-Dip Galvanized

7) Washer, Lock Spring 1/2 Galv

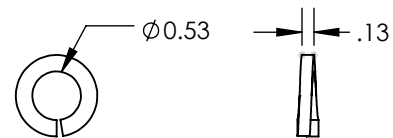

Property	Value
Material	Steel
Finish	Hot-Dip Galvanized

8) Nut, Hex 1/2-13 Galv

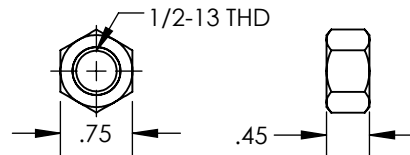

Property	Value
Material	Steel
Finish	Hot-Dip Galvanized