

ITEM NO.	DESCRIPTION	QTY.
1	U-FOOT	1
2	NORTH TILT LEG, 1.5" SQ, LENGTH VARIES	1
3	PRE-ASSEMBLED SOUTH TILT LEG	1
4	NUT, FLANGE HEX 3/8-16 SS	3
5	WASHER, FLAT 3/8 SS	1
6	BOLT, 3/8-16 X 2.5" CS SST	1
7	BOLT, BONDING 3/8-16 SQ HEAD, 2.25"	1
8	BOLT, BONDING 3/8-16 SQ HEAD, 1.0"	1

Part Number	Description	North Tilt Leg Length
TM-FTL-007	Kit, Fixed Tilt Leg, 7", Mill	7"
TM-FTL-010	Kit, Fixed Tilt Leg, 10", Mill	10"
TM-FTL-015	Kit, Fixed Tilt Leg, 15", Mill	15"
TM-FTL-020	Kit, Fixed Tilt Leg, 20", Mill	20"
TM-FTL-025	Kit, Fixed Tilt Leg, 25", Mill	25"
TM-FTL-030	Kit, Fixed Tilt Leg, 30", Mill	30"

1) U-Foot

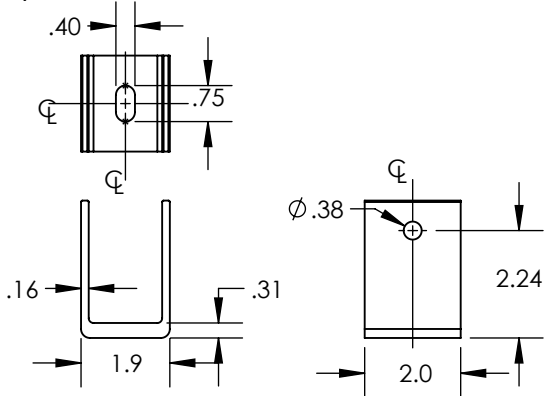

Property	Value
Material	Aluminum
Finish	Mill

2) North Tilt Leg

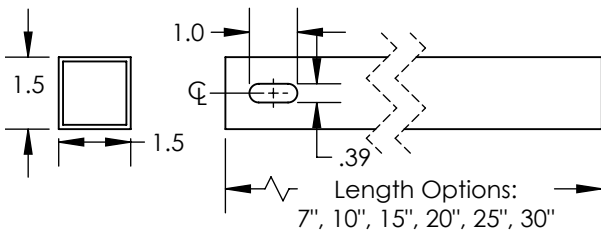

Property	Value
Material	Aluminum
Finish	Mill

3) Pre-assembled South Tilt Leg

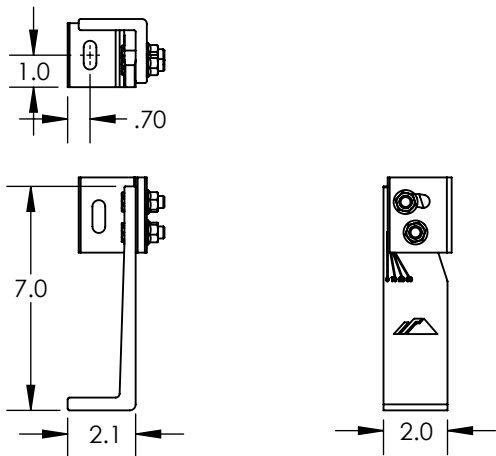

Property	Value
Material	Aluminum
Finish	Mill

4) Nut, Flange Hex 3/8-16 SS

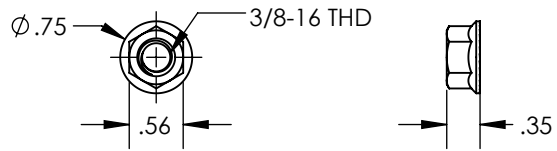

Property	Value
Material	Stainless Steel
Finish	Clear

5) Washer, Flat 3/8 SS

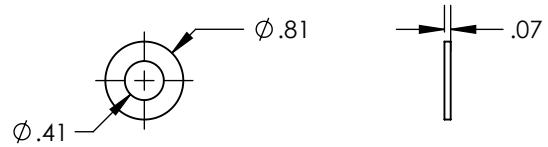

Property	Value
Material	Stainless Steel
Finish	Clear

6) Bolt, 3/8-16 X 2.5" CS SS

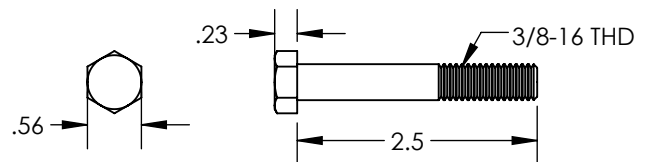

Property	Value
Material	Stainless Steel
Finish	Clear

7, 8) Bolt, Bonding 3/8-16 Sq Head

1.0"

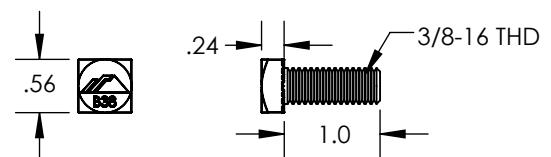

2.25"

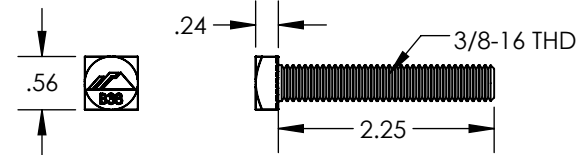

Property	Value
Material	Stainless Steel
Finish	Clear