

REVISIONS		
REV	DESCRIPTION	DATE

MATERIAL

FINISH

DRAWING INTERPRETATIONS	
PROJECTIONS	DIMENSIONS
	INCHES MILLIMETERS

UNSPECIFIED TOLERANCES
DECIMALS ±.020 (±.510 mm); ANGULAR ±1°

DRAWN BY: MM 4-18-13	CHECKED BY:	SCALE NONE
APPROVED BY:	DATE APPROVED	

DO NOT SCALE DRAWING

TITLE
**"C SERIES"
CIRCUIT BREAKER**

Carling Technologies
CIRCUIT BREAKER DIVISION
PLAINVILLE, CT

SIZE B	DRAWING NO. CB2-X0-19-009-X21-XA	REV 01
SHEET 1 OF 1		

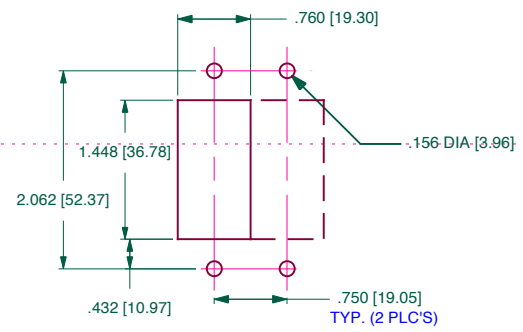
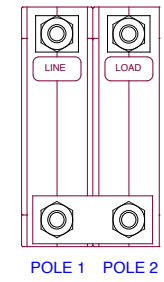
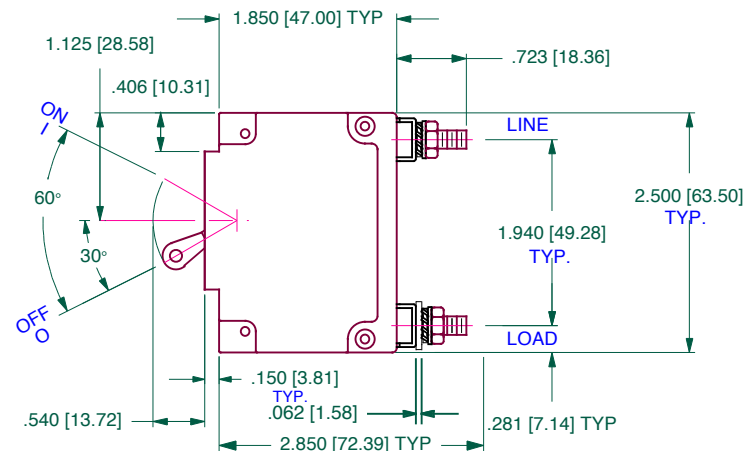
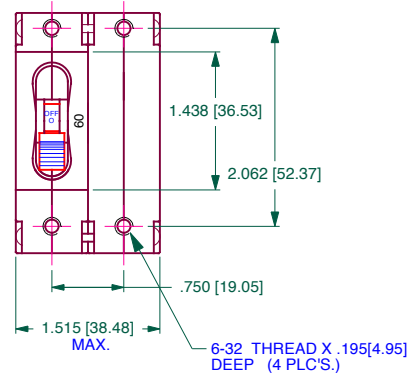

PANEL CUTOUT DETAIL
TOLERANCES ±.005 [.12]

LABEL INFORMATION:

P C GPA V HZ TD
1-2 B0 60.0 300 DC 14
Series connected

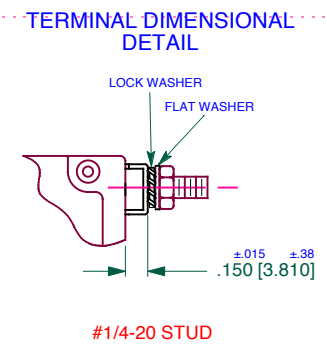



CONTROL SYMBOLS	
	CRITICAL
	MAJOR

TOOL NO.	REV
REFERENCE NO.	
SHEET	OF

REVISIONS		
REV	DESCRIPTION	DATE

MATERIAL

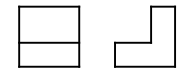
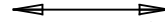
FINISH

DRAWING INTERPRETATIONS	
PROJECTIONS	DIMENSIONS
	INCHES  MILLIMETERS 

UNSPECIFIED TOLERANCES
 DECIMALS ±.020 (±.510 mm); ANGULAR ±1°

DRAWN BY: MM	CHECKED BY: ME	SCALE NONE
6-25-10	6-25-10	
APPROVED BY: ECKELS	DATE APPROVED 6-25-10	

DO NOT SCALE DRAWING

TITLE
**"C SERIES"
 CIRCUIT BREAKER**

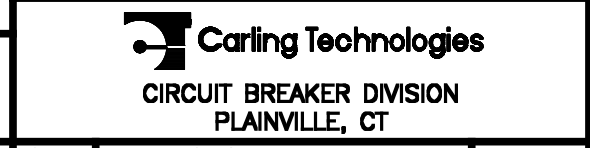

SIZE B	DRAWING NO. CB2-X0-18-255-X11-XA	REV 01
------------------	--	------------------

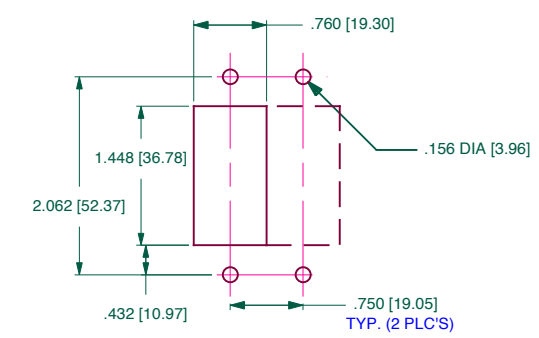
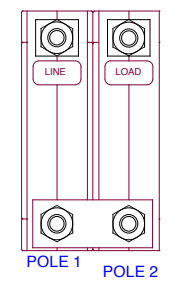
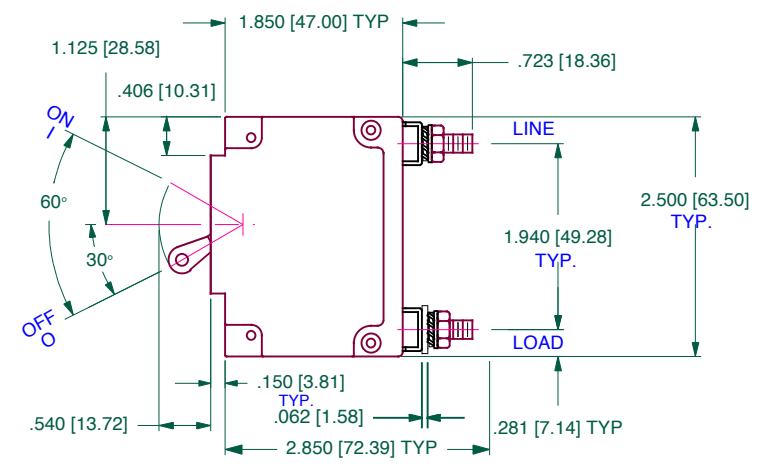
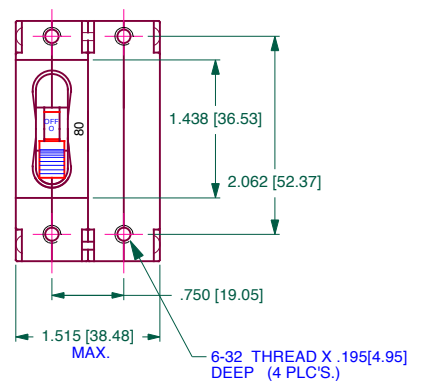



PANEL CUTOUT DETAIL
 TOLERANCES ±.005 [.12]

LABEL INFORMATION:

P C GPA V HZ TD
 1-2 B0 80.0 300 DC 14
 Series connection

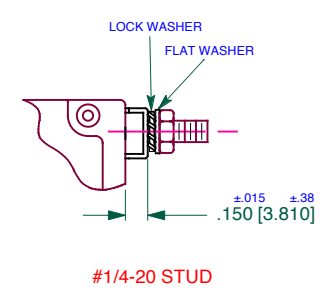
TERMINAL DIMENSIONAL DETAIL



CONTROL SYMBOLS	
	CRITICAL
	MAJOR

TOOL NO.	REV
REFERENCE NO.	
SHEET	OF